

SMARTTECH

ACCESSORIES⁺

SMART BATTERY CHARGER

MODELS: STC6

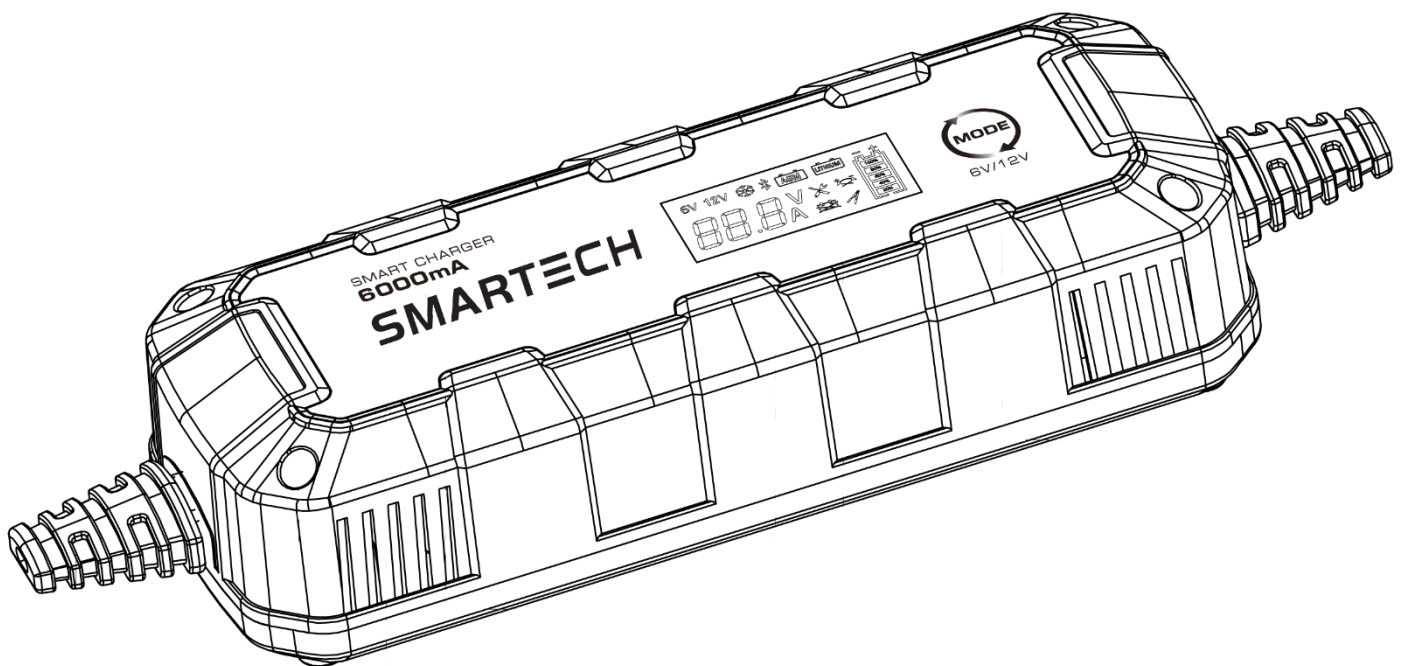

INSTRUCTION MANUAL

Important Safety Instructions

Please read this manual thoroughly before use and store in a safe place for future reference. This manual contains important safety instructions.

WARNING

- Before using the charger, please read the instructions carefully.
- Explosive gases may escape from the battery during charging. Prevent flames and sparks. Provide adequate ventilation.
- For charging 6 Volt and 12 Volt lead acid and lithium LiFePO₄ batteries only.
- Do not expose charger to rain or snow.
- Use of an attachment not recommended for the battery charger may result in a risk of fire, electric shock, or injury to persons.
- Disconnect the 240V AC mains supply before making or breaking
- the connections to the battery
- The battery charger must be plugged into an earthed socket-outlet.
- Connection to supply mains is to be in accordance with National wiring rules.
- Do not operate charger with damaged cord or plug. It must be replaced or repaired by a qualified person.
- Do not attempt to charge non-rechargeable batteries.
- Never charge a frozen battery
- Ensure all vehicle accessories including lights, heaters, appliances, etc are turned off prior to charging.
- The charger may not be used as a starting aid.
- This appliance is not intended for use by young children or infirm persons unless they have been adequately supervised by a responsible person to ensure that they can use the appliance safely.
- Please store disconnected and out of reach of unsupervised children.

CONTENTS

- 1. STC6 Smart charger x 1
- 2. Clamp cable x 1
- 3. Ring terminal harness x 1
- 4. Fuse x 1
- 5. User Manual x 1

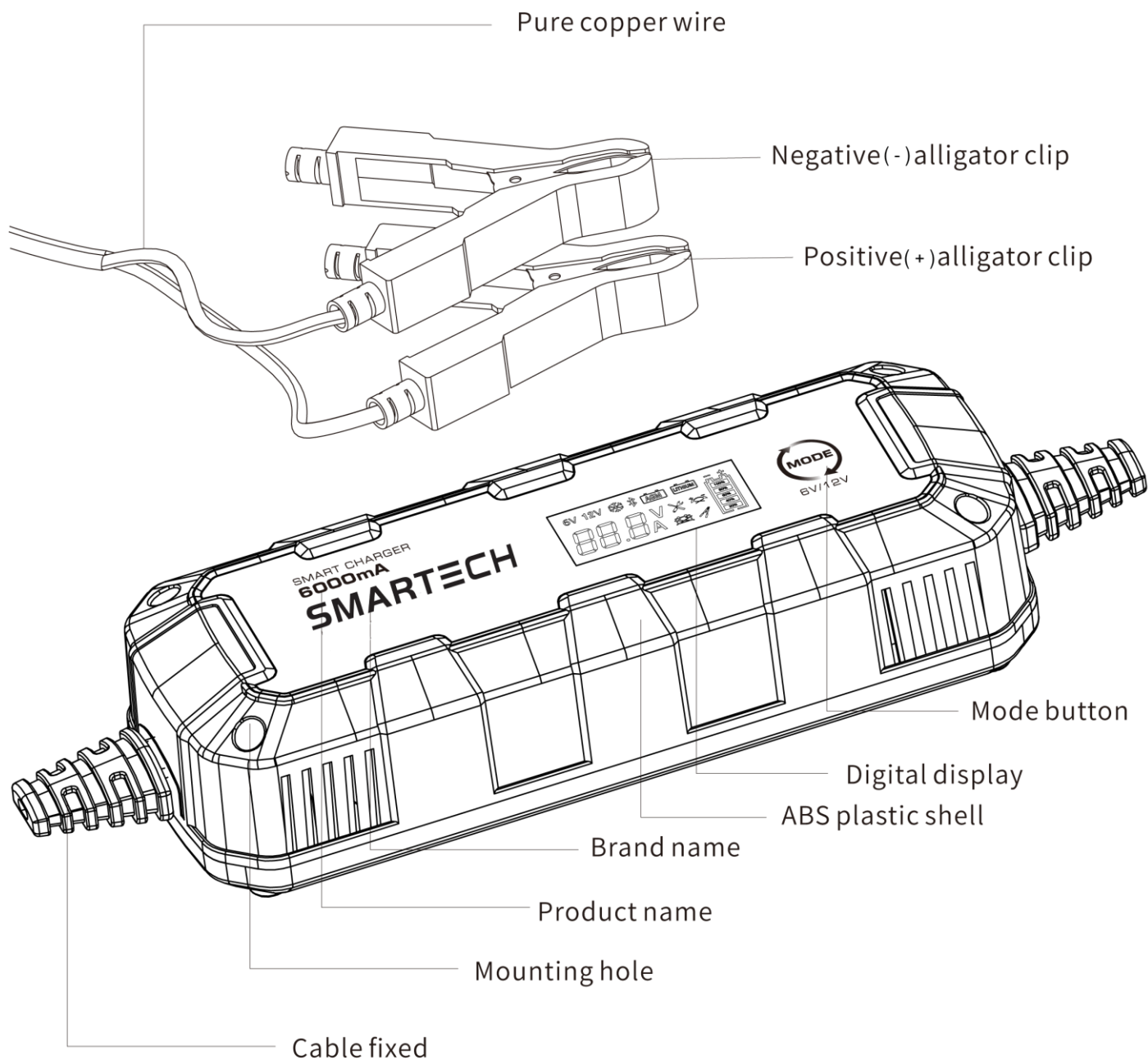

FEATURES

8-STAGE SMART CHARGING

This is a fully automatic battery charger with 8 charge stages.

All Smartech chargers are equipped with a sophisticated micro processing controller that ensures optimal charge is delivered to the battery whilst protecting the battery from being overcharged.

8-stage charging is an accurate and comprehensive charging process that will result in better battery performance and longer life expectancy when compared to traditional chargers.

Smartech 8-stage smart chargers are suitable for many 6V and 12V battery types including LiFePO4 batteries, Absorbent Glass Mat (AGM) batteries, Colloidal Sealed Lead-Acid (GEL) batteries, Maintenance Free and Calcium batteries.

The 8 charge stages are:

Diagnosis, Pulse, Soft Start, Bulk Charge, Absorption, Analysis, Equalization and Float.

STAGE 1 – DIAGNOSIS

The Micro Controller Unit (MCU) will analyse the condition of the battery to provide correct charge or prevent the charging of a defective battery.

STAGE 2 – PULSE

If necessary, a Pulse charge is applied to aid in reducing the build up of sulphate crystals on the plates of a discharged lead acid battery. This method is also known as Desulphation. This stage does not apply to Lithium Mode.

STAGE 3 – SOFT START

Start the charging process with a gentle (soft) charge.

STAGE 4 – BULK CHARGE

Constant Current charging until desired voltage is reached.

STAGE 5 – ABSORPTION

Constant Voltage charging. Current will diminish as the MCU maintains a constant voltage until fully charged.

STAGE 6 – ANALYSIS

Charger output will stop, and the charger will analyse the battery to ensure it holds its charge.

STAGE 7 – EQUALIZATION

After analyzing the battery, the charger may start to charge the battery at a higher voltage in order to balance the voltage of each cell. This stage does not apply to Lithium Mode.

STAGE 8 – FLOAT

The MCU will continue to monitor the voltage and apply a maintenance charge as required.

SWITCHMODE TECHNOLOGY

Using the latest technology in battery chargers, switchmode chargers convert 240V AC power to 12V DC power using electronic components unlike traditional battery chargers that rely on heavy transformers. This allows the charger to be lightweight and compact without sacrificing on performance.

SPARKPROOF & POLARITY PROTECTION

Prevents the output leads from sparking due to accidental reverse connection or short circuit, making the charger safer to use around batteries.

SHORT CIRCUIT PROTECTION

The charger provides protection against excessive currents, short circuits and overloads. If such a fault is detected during charging, the charger will automatically terminate the charging program.

OVER VOLTAGE PROTECTION

The charger will provide protection against voltages that exceed the acceptable voltage rating. If such a fault is detected during charging, the charger will automatically terminate the charging program.

OVER TEMPERATURE PROTECTION

If the charger's internal temperature limit is exceeded, the over temperature protection will be triggered to protect the unit against overheating.

ADJUSTABLE CHARGE VOLTAGE

The charger's voltage can be selected to suit 6V or 12V batteries.

AUTOMATIC BMS ACTIVATION

When the charger is set to LITHIUM mode the charger will automatically re-activate a LiFePO4 Battery Management System that has shut down to protect the battery.

LCD DISPLAY

User friendly LCD display screen, which will show the following functions:



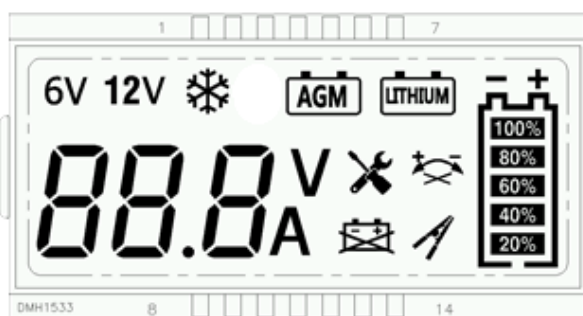



- Charge Mode
- Charge Voltage selected
- Charging Current
- State of Charge
- Error Codes



BATTERY TYPE OUTPUT VOLTAGE

Battery Type	6V	6V Float Voltage	12V	12V Float Voltage
Standard Battery	7.2±0.2V	6.8±0.2V	14.4±0.2V	13.6±0.2V
AGM	7.4±0.2V	6.8±0.2V	14.8±0.2V	13.6±0.2V
LifePO4	7.4±0.2V	7.1±0.2V	14.6±0.2V	13.6±0.2V

CHARGE MODES

MODE	EXPLANATION
STANDBY	The charger stays in Standby mode automatically when the charger is connected to AC power. In standby mode, the charger does not charge or supply power to the battery. In this mode, power from the AC socket is on standby until a mode is selected.
6V	For charging 6 Volt Lead Acid, Enhanced Flooded, Maintenance-free and Calcium batteries.
6V 	For charging 6 Volt AGM/Dry Cell batteries.
6V 	Used for the winter mode of 6V lead-acid battery. When selected this mode, it will charge only for 6V lead-acid battery in winter period.
6V 	For charging 6 Volt Lithium (LiFePO4) batteries.
12V	For charging 12 Volt Lead Acid, Enhanced Flooded, Maintenance-free and Calcium batteries.
12V 	For charging 12 Volt AGM/Dry Cell batteries.
12V 	Used for the winter mode of 12V lead-acid battery. When selected this mode, it will charge only for 12V lead-acid battery in winter period.
12V 	For charging 12 Volt Lithium (LiFePO4) batteries.
	For charging batteries that have been stored for a long time without charging. Charger may detect a bad battery and automatically enter this mode.

CHARGING INSTRUCTIONS

STEP 1 – CHARGE PREPARATION AND SAFETY PRECAUTIONS

Read this manual thoroughly, follow instructions and adhere to safety precautions. Ensure the charger is in a safe location away from the battery. Do not operate charger in a closed-in area or restrict ventilation in any way.

Study the battery manufacturer's specific precautions, recommended rates of charge and determine the correct voltage of the battery.

STEP 2 – CONNECT TO 240V MAINS POWER

Connect the battery charger to the 240V mains powered socket and turn on the mains power. The plug must be plugged into an outlet that is properly installed in accordance with all local codes and ordinances and never alter AC cord or plug provided. The charger will start in standby mode with a green LED indication.

STEP 3A – CONNECT TO BATTERY OUT OF VEHICLE

Connect the RED output lead (battery clip) from the charger to the Positive (+) battery terminal and ensure a good connection is made.

Connect the BLACK output lead (battery clip) from the charger to the Negative (-) battery terminal and ensure a good connection is made.

STEP 3B – CONNECT TO BATTERY IN VEHICLE

Before connecting, determine if the vehicle is Negatively (-) or Positively (+) earthed. Negative earthed vehicles are most common and use the chassis as an earth by connecting the battery negative terminal to a conductive chassis point.

If you are unsure, please seek advice from a qualified person before connecting.

Negatively Earthed

Connect the RED lead (battery clip) from the charger to the Positive (+) battery terminal. Connect the BLACK lead (battery clip) from the charger to the vehicle's chassis away from the fuel line or moving parts. Always ensure a good connection is made.

Positively Earthed

Connect the BLACK lead (battery clip) from the charger to the Negative (-) battery terminal.

Connect the RED lead (battery clip) from the charger to the vehicle's chassis away from the fuel line or moving parts. Always ensure a good connection is made.

STEP 4 – SET MODE

The mode should be set according to the type and voltage of the battery. To set, press the MODE button repeatedly until desired mode is displayed.

STEP 5 – CHARGING



During the charging process, the LCD screen will show the mode selected and the state of charge. The LCD screen will show the current and battery voltage. When the charging process is complete the State of charge will show 100%. In this state the charger will remain in float mode until the battery clamps are disconnected. If there is an error in charging, then the fault icons will appear.

STEP 6 – DISCONNECTION



Ensure the 240V mains switch is turned off and the charger is disconnected from the 240V mains power before disconnecting clamps from the battery.

FAULTS & ERRORS

The Smartech chargers sophisticated smart MCU will determine multiple issues with the charging process or the battery. If a fault is recognized the charger will display a series of blink sequences that help you identify the cause of the error and potential solutions. All Error Conditions are displayed with the Error LED and Standby LED flashing back and forth. The number of flashes between each pulse denotes a potential Error Condition. See the table below for more information.

ICON	CAUSE	REMEDY
 E01	AC output short circuit	Disconnect the charger and check your AC plug for damage. Fix if necessary/possible.
 E02	Bad Connection	Disconnect the clamps and then reconnect them appropriately. Ensure the poles and clamps are clean for good contact. It may be necessary to clean the battery terminals to ensure good contact.
 E03	Reverse Polarity	Check the clips are connected to the correct polarity and have a good clean contact to the terminal. Make sure the clips are not touching each other.
E04	Over Temperature protection	Stop charging and check and fix connection. Allow charger to cool down before resuming charge process.

TECHNICAL SPECIFICATIONS

Model:	STC6
Charger Type:	8 stage Automatic charger – Normal and AGM lead acid 6 stage Automatic charger – LiFePO4
Input:	220~240V AC 50Hz – 60Hz
Power:	120W max
Output:	6 Vdc, 6000mA 12 Vdc, 6000mA
Minimum Start Voltage:	2.0V
Float Current:	300mA \pm 200mA
Functions:	Float charging, reverse polarity protection, short circuit protection, Over voltage protection, overheating protection, LiFePO4 BMS Reactivation.
Ambient Temperature:	0°C to 40°C
Thermal Protection:	95°C
Cooling:	Natural Cooling
Types of Batteries:	LiFePO4, AGM, GEL, Maintenance Free Lead Acid, Calcium Lead Acid
Cable Lengths:	AC cable: 1.4m Output cable: 1.8m
Dimensions:	201 x 75 x 49mm
Weight:	0.35Kg
Fuse Rating:	T3.15A 250V
Protection:	IP20
Protection Class:	
Certifications:	 

WARRANTY STATEMENT

APPLICABLE ONLY TO PRODUCTS SOLD IN AUSTRALIA

Our goods come with guarantees that cannot be excluded under the Australian Consumer Law. You are entitled to a replacement or refund for a major failure and compensation for any other reasonably foreseeable loss or damage. You are also entitled to have the goods repaired or replaced if the goods fail to be of acceptable quality and the failure does not amount to a major failure.

All claims are subject to Super Start Batteries Pty Ltd standard testing procedures by its authorized representatives. Should a product be deemed defective due to a manufacturing fault and is within its applicable warranty period; it will be replaced with an equivalent product free of charge.

The product is guaranteed to be free from defects in workmanship and parts for a period of 12 months from the date of purchase. This warranty does not cover ordinary wear and tear, abuse, alteration of products, damage caused by the consumer, changes in the condition or operational qualities of the product resulting from incorrect storage, or other influences. Warranty does not include transit costs if the product is sent back for a claim.

Proof of purchase is required to make a claim. The warranty period is not renewed or extended as a result of a repair or replacement. The warranty is not transferable and is only offered to the original end user of the product.

If you believe your product to be defective due to a manufacturing fault you must deliver the product at your cost to the original place of purchase. Alternately, you may contact Super Start Batteries Pty Ltd directly to arrange for it to be returned to our head office or a nominated distributor for assessment. If the product is confirmed as defective we will repair or replace it under the terms of the relevant warranty. If a product is deemed by our testing not to be faulty, you have the choice to have the product returned at your cost. You must also deliver the original invoice evidencing the date and place of purchase together with an explanation in writing as to the nature of the claim.

Distributed By

Super Start Batteries Pty L:td

Head Office:

Unit 30, 76 Hume Highway

Lansvale, NSW 2166

Telephone: (02) 9755 7851

Facsimile: (02) 9755 7852

Website: www.superstart.com.au/

SMARTTECH
ACCESSORIES⁺