

INTELLI-RV

POWER MANAGEMENT SYSTEMS FOR RVs



INTELLI-RV

POWER MANAGEMENT SYSTEM RANGE

Projecta's Intelli-RV range offers a comprehensive power management system solution to suit caravans and recreational vehicles, providing easier, safer installation and battery/solar management. Within the range are four different kits offering customers a variety of features and components to suit their application and budget. Designed with 'plug and play' in mind, to complete wiring installation you only need a screwdriver and the necessary DC cables.

PM100



PM200



Fast and efficient wiring to a central location via push-in termination of solid, stranded and ferruled conductors — wire up your whole caravan in half of the time with the WAGO® easy push-in terminals (excluding PM100). These terminals have industry-proven spring pressure connection technology, meaning fast, vibration-proof and maintenance-free wiring. Up to 14 fused outputs are available depending on model, plus remote control/monitoring and switch panels for the ultimate setup.

PM300



PM400



INTELLI-RV

POWER MANAGEMENT SYSTEM IN ACTION

PM400 pictured

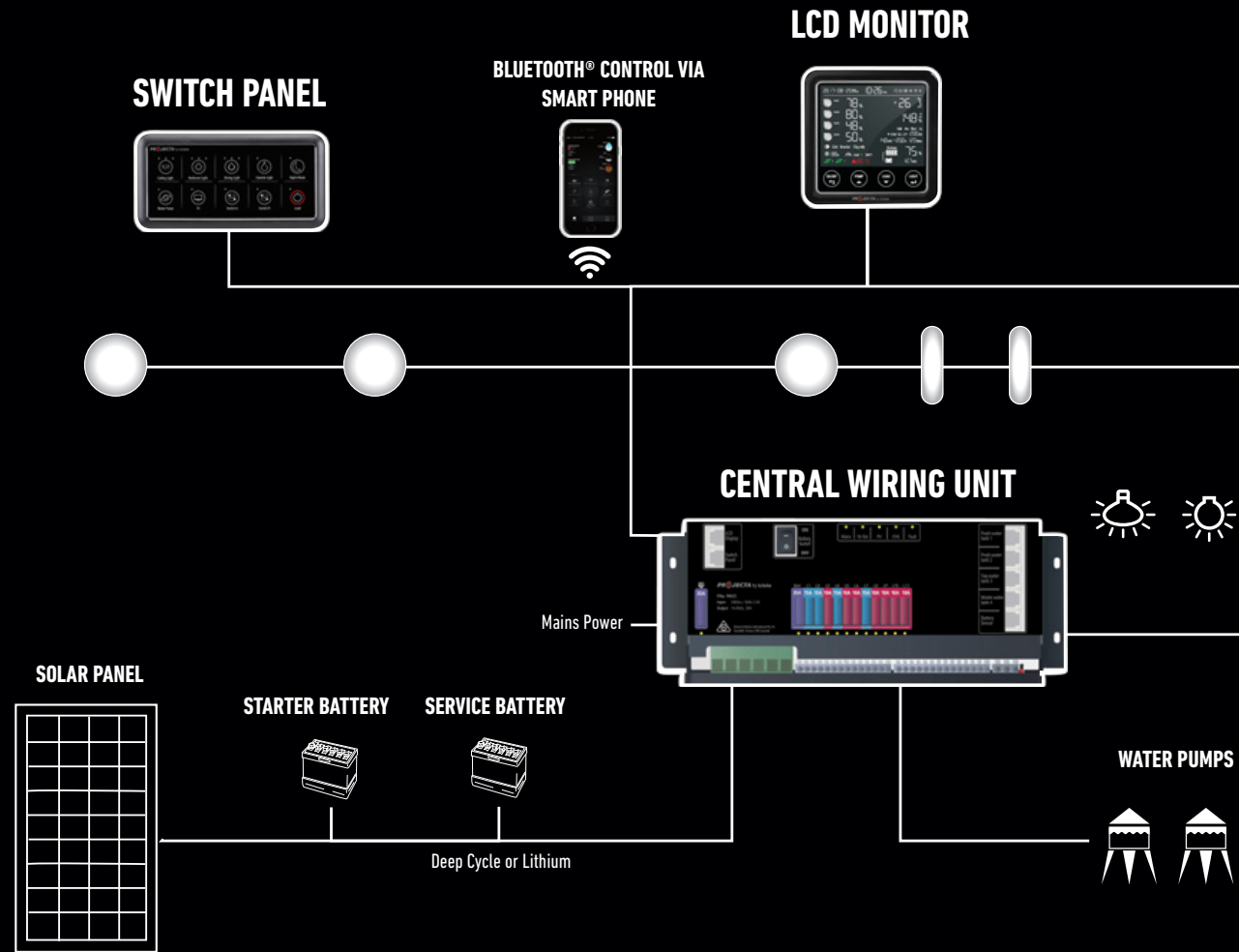

With 11 Outputs

Managing power to run your 12V DC appliances and lighting



BEDROOM LIGHT SWITCHES



LIGHTING SWITCHES (up to 6)

On/Off — Monitors 1 - 3 Water Tank Levels
— Monitors 1 x Grey Water Tank Level



INTELLI-RV POWER MANAGEMENT SYSTEM CHARGING CYCLE

5 STAGE CHARGING

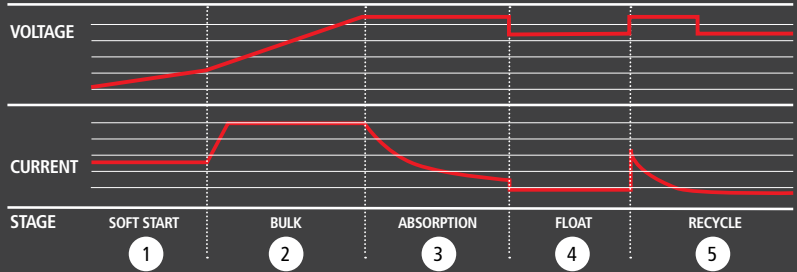

- 1 SOFT START**
Increases battery life by gently starting to charge the battery 50% of bulk
- 2 BULK**
Reduces charging time by delivering maximum charge to set voltage
- 3 ABSORPTION**
Ensures a full charge to the battery without overcharging
- 4 FLOAT**
Float charge maintains the battery at 100% charge
- 5 RECYCLE**
Restarts the charge cycle every 10 days



INTELLI-RV

FEATURES AT A GLANCE

All models feature a switchable 35A power supply, 20A mains battery charging, and 100A VSR* for dual battery charging. PM200 features a PWM solar controller, whilst PM300 and PM400 utilise full MPPT. Remote control displays (LED on PM200, LCD on PM300/PM400) offer easy monitoring of water levels, battery, charging and system status, plus remote buttons for power, load and water pump operation. PM400 also includes a separate switch panel for turning lights and appliances off and on, dimmable bedroom light switches and Bluetooth® connectivity for operation via smart phone. A host of inbuilt protections across the range ensure safe operation and care of batteries for a true 'set and forget' experience.



PM100

Entry level system for set and forget battery system management. Includes centralised wiring, 35A power supply and 20A charge

PM200

As above but with a remote L.E.D display to keep you informed at all times. Display features 3 water level and sensor inputs, switches for water pump, night mode buttons and 30A PWM solar.

PM300

A comprehensive unit with remote LCD display incorporating battery monitoring (V, A, SOC), up to 4 water level inputs, pump and load switchable and 30A MPPT solar.

PM400

A complete solution for the most advanced setups. A centralised switch panel combines bedroom switches with dimmable light outputs for mood lighting. Remote LCD display and Bluetooth® connectivity for monitoring via smart phone.

35A POWER SUPPLY
100A VSR VEHICLE CHARGE
WATER LEVEL & PUMP CONTROL
WAGO TERMINALS
REMOTE CONTROL DISPLAY
SOLAR CONTROLLER
BLUETOOTH®

L.E.D

30A PWM

L.C.D

30A MPPT

L.C.D

30A MPPT

*100A for 30mins 60A continuous



INTELLI-RV PM100



The entry level system for set-and-forget battery system management. Includes centralised unit for neat and easy wiring of lighting and electricals, 35A power supply, 5 stage charging via DC 100A VSR* or 20A charge via AC plug.

PM100 connects your service/caravan battery to the vehicle starter battery and ensures alternator charge prioritises the starter battery first. It protects the voltage of the starter battery so you can start your car every single time, even with a heavy load on the auxiliary. Features 10 channel fused output via screw terminals, L.E.D status indicators and charge or power supply switch.



10 Channel fused output, screw terminals

L.E.D Status Indicators

Power Supply or Charge Mode Switch conveniently located next to status indicators

FEATURES AT A GLANCE

For **PM100** full component list see INTELLI-RV PRODUCT RANGE COMPONENTS



Voltage Sensitive Relay engages and disengages with engine operation

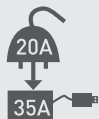

20A Charger
35A Power Supply

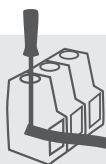

Screw terminals for input and output



Charge or Power Supply Switch



LVD to protect the battery from deep discharge

*100A for 30mins 60A continuous

INTELLI-RV PM200



Voltage Sensitive Relay engages and disengages with engine operation

Including all the great features of PM100, plus the addition of a 30A PWM solar charge controller, a remote control L.E.D display to keep you informed and a larger 14 channel fused output with WAGO® terminals.

PM200's remote display features 3 water levels, starter and service battery voltages, switch for water pump control, night mode buttons and load on/off switch. The 30A PWM solar input allows the user to rely on solar during sunny conditions or DC when it's not. WAGO® terminals make installation and changes to wiring a breeze, whilst a manual battery switch connection allows for remote or local operation.

14 Channel fused output, Wago® Terminals



30A PWM solar input

WAGO® terminals for easy wiring

1x Water pump control

L.E.D Switch Panel



Volt meter

Indicators:
 • Solar
 • PV
 • Fault

Water levels

Switches:
 • Water Pump
 • Power Load
 • Night Mode (L.E.Ds and fan off)

FEATURES AT A GLANCE

For **PM200** full component list see INTELLI-RV PRODUCT RANGE COMPONENTS

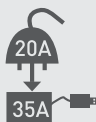

20A Charger,
35A Power Supply

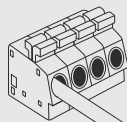

WAGO® Terminals for easy wiring



Manual Battery Switch connection for remote and local operation



PWM Solar Input



Water Level & Pump Control

INTELLI-RV PM300



Voltage Sensitive Relay engages with engine operation

A comprehensive system building on all the functionality of PM200, but with a remote LCD display offering advanced monitoring of battery, solar, water and electrical systems, plus a full MPPT 30A solar charge controller.

PM300's remote LCD control features battery and charging information (Volts, AMPs, SOC, time remaining), up to 4 water tank level inputs with pump control, a load switch, night mode and silent mode for quiet operation. 14 channel fused output and WAGO® terminals, plus a host of protection features and sensors ensure easy, safe operation and monitoring of your electricals.

MPPT Solar Output

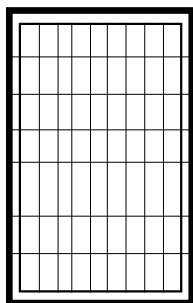

- Built-in Maximum Power Point Tracking (MPPT) solar regulator allows maximum power from portable solar panels, even in low light conditions
- 30A MPPT Solar input (Input up to 50Vdc)
- Designed to charge an auxiliary battery from multiple sources: 12V solar, DC or 240V mains

LCD Monitor



FEATURES AT A GLANCE

For **PM300** full component list see INTELLI-RV PRODUCT RANGE COMPONENTS

20A Charger,
35A Power Supply

Wago® Terminals
Screw terminals for high power
1 x water pump control

Manual Battery Switch
connection for remote
and local switch

MPPT Solar Input

Water Level &
Pump Control

INTELLI-RV PM400



Voltage Sensitive Relay
engages and disengages
with engine operation



20A Charger
35A Power Supply

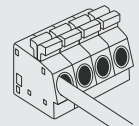

Wago Terminals
Screw terminals for high power
1 x water pump control

The ultimate in power management systems, **PM400** encompasses a complete remote control solution for the most advanced setups. Utilising an 11 channel central wiring unit and MPPT, it includes **PM300's** advanced LCD display plus a central switch panel, bedroom light/dimming switches and smart phone **Bluetooth®** operation.

The central switch panel can be mounted anywhere and allows remote operation of water pump, lighting and appliances, plus a master switch and night mode. Bedroom lighting switch panels enable light and dimming control from the comfort of your bed. Bluetooth® connectivity means you can control and monitor your power system and appliances from inside or outside using the smart phone app – great for outdoor light switching.



MPPT Solar Output

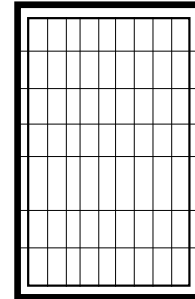

- Built-in Maximum Power Point Tracking (MPPT) solar regulator allows maximum power from portable solar panels, even in low light conditions
- 30A MPPT Solar input (Input up to 50Vdc)
- Designed to charge an auxiliary battery from multiple sources: 12V solar, DC or 240V mains

Switch Panels

2x Bedroom light switches



Night Light with 5 dimmer levels



Night mode (All backlights and fan off)

Bluetooth® Connectivity



Control/monitor via smart phone

FEATURES AT A GLANCE



Manual Battery Switch connection for remote and local operation



Centralised switch panel



Bedroom switch x2



Wiring specific cables



MPPT Solar Input



Water Level & Pump Control

For **PM400** full component list see INTELLI-RV PRODUCT RANGE COMPONENTS

INTELLI-RV INSTALLATION

Easy Installation

Designed to significantly reduce electrical footprint and installation time, Projecta's PM range eliminates the need to install extra battery protection parts, as it is all contained within the central unit. Most of what's required is already in the box. Self-terminating connectors enable an efficient, time-saving direct wiring scheme with less criss-crossing of the vehicle or caravan.

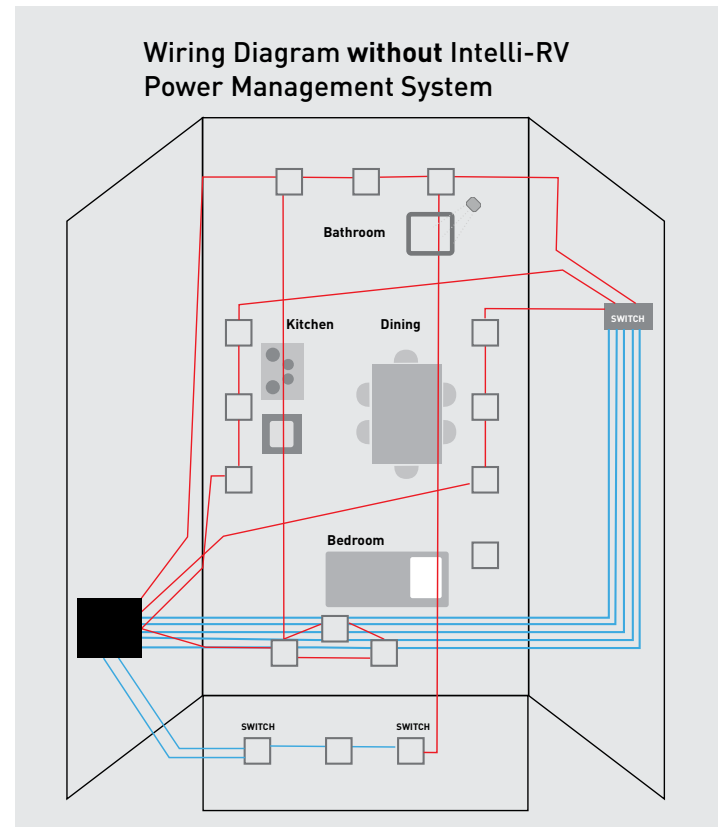
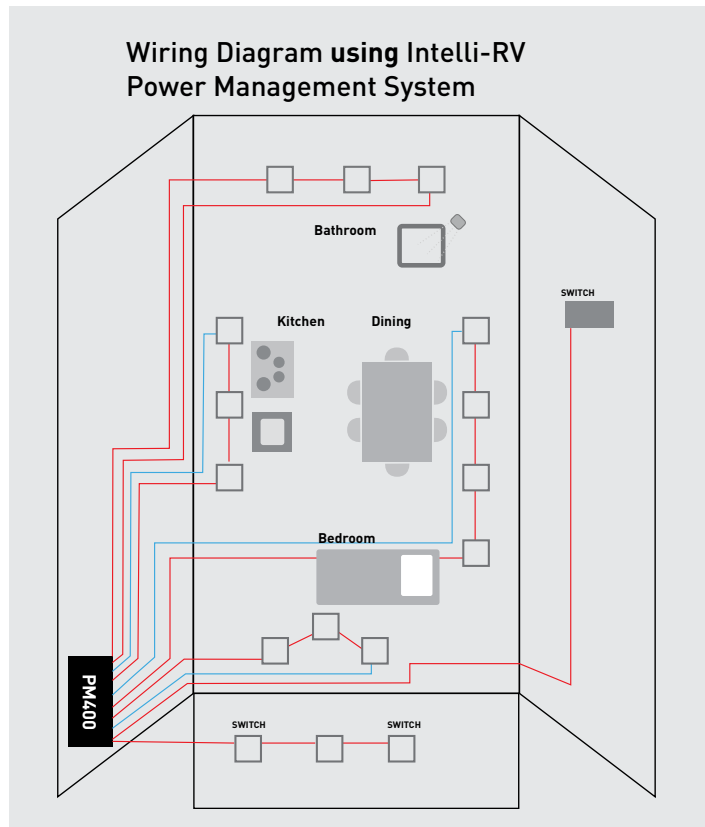

INTELLI-RV WIRING

WAGO® Terminals – Benefits

WAGO® easy push-in terminals (excluding PM100) utilise industry-proven spring pressure connection technology, meaning fast, vibration-proof and maintenance free wiring. Wiring looms for switch panels are supplied where required, enabling fast and secure connection to the central unit. Screw terminals allow completion of the wiring installation with just a screwdriver.

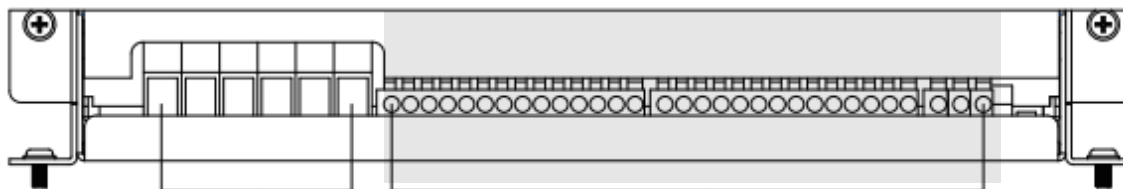

SCREW Terminals

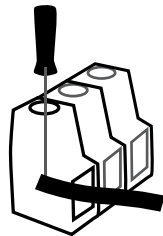

Connection of Screw Terminals

WAGO® Type Terminals

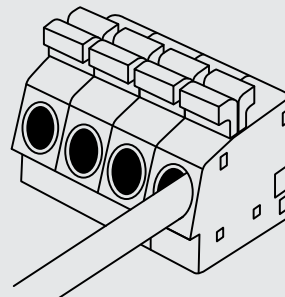

Connection of WAGO® Type Terminals

INTELLI-RV COMPONENT LIST

COMMON ACCESSORIES

PMTEX-2	2m Extension Cable for Temperature Sensor
PMTEX-4	4m Extension Cable for Temperature Sensor
PMAC	AC Power Cord, 1.5m
PMBS	Battery Sensor with 3m of Cable
PMBEX-2	2m Extension Cable for Battery Sensor
PMBEX-4	4m Extension Cable for Battery Sensor
PMLCDC	5m Cable to suit LCD Screen (Crystal Display)
PMSWEX-2	2m Extension Cable for Panel Switch, LED and LCD Monitor
PMSWEX-4	4m Extension Cable for Panel Switch, LED and LCD Monitor
PMWS200	200mm Water Sensor with 4m Cable
PMWS400	400mm Water Sensor with 4m Cable
PMWEX-4	4m Extension Cable for Water Sensor

PM100

PM100	12V 20A Charger and 35 Amp Power Supply
-------	---

PM200

PM235	12V 20A Charger and 35 Amp Power Supply, 30A Solar Controller
PMSWLED	LED Display to suit PM235
PMSWLEDC	5m, Cable to suit PMSWLED
PMBS	Battery Sensor with 3m of Cable
PMAC	AC Power Cord, 1.5m
PM200 Accessories and Spares	
PMBS	Battery Sensor with 3m of Cable
PMBEX-2	2m Extension cable for Battery Sensor
PMBEX-4	4m Extension cable for Battery Sensor
PMSWEX-2	2m Extension Cable for Panel Switch, LED and LCD Monitor
PMSWEX-4	4m Extension Cable for Panel Switch, LED and LCD Monitor
PMWS200	200mm Water Sensor with 4m Cable
PMWEX-4	4m Extension Cable for Water Sensor



PM300

PM335	12V 20A Charger and 35 Amp Power Supply, 30A MPPT Solar Controller
PMLCD	LCD Display to suit PM335
PMLCDC	5m Cable to suit LCD Screen
PMTS	Temperature Sensor with 5m Cable to suit PM Units for Amoy System
PMBS	Battery Sensor with 3m of Cable
PMAC	AC Power Cord, 1.5m
PM300 Accessories and Spares	
PMTEX-2	2m Extension Cable for Temperature Sensor
PMTEX-4	4m Extension Cable for Temperature Sensor
PMBEX-2	2m Extension Cable for Battery Sensor
PMBEX-4	4m Extension Cable for Battery Sensor
PMSWEX-2	2m Extension Cable for Panel Switch, LED and LCD Monitor
PMSWEX-4	4m Extension Cable for Panel Switch, LED and LCD Monitor
PMWS200	200mm Water Sensor with 4m Cable
PMWEX-4	4m Extension Cable for Water Sensor

PM400

PM435	12V 20A Charger and 35 Amp Power Supply, 30A MPPT Solar Controller, Dimmable Lights
PMLCD-BT	LCD Display with Bluetooth® to suit PM435 & PM335
PMLCDC	5m Cable to Suit LCD Screen
PM4SW10	10 Position Switch Panel
PM4Y	CY Connection to suit PM4SW10C & PM4TS
PM4SW10C	4.5m Cable to suit 10 Position Switch Panel (PM4SW10)
PM4SW2	2 Position Switch Panel
PM4SW2Y	Y Connection 0.5m Cable to suit 2 Position Switch Panel (PM4SW2)
PMSWEX-4	4m Extension Cable for Switch Panel, LED and LCD Monitor
PMBS	Battery Sensor with 3m of Cable
PM4TS	Temperature Sensor with 5m cable to suit PM400
PMAC	AC Power Cord, 1.5m
PM400 Accessories and Spares	
PMBEX-2	2m Extension Cable for Battery Sensor
PMBEX-4	4m Extension Cable for Battery Sensor
PMSWEX-2	2m Extension Cable for Switch Panel, LED and LCD Monitor
PMSWEX-4	4m Extension Cable for Switch panel, LED and LCD Monitor
PMWS200	200mm Water Sensor with 4.5m Cable
PMWEX-4	4m Extension Cable for Water Sensor



AUSTRALIA

HEAD OFFICE

Brown & Watson
International Pty. Ltd.
1500 Ferntree Gully Road,
Knoxfield, Victoria 3180
Phone: (03) 9730 6000
National Toll Free: 1800 113 443
Fax: (03) 9730 6050
Email: info@projecta.com.au
www.projecta.com.au



**NEW ZEALAND
HEAD OFFICE**

Griffiths Equipment Ltd
22-24 Olive Road,
P.O. Box 12556 Penrose,
Auckland, N.Z.
Phone: (09) 525 4575
Fax: (09) 579 1192
Email: info@projecta.co.nz
www.projecta.co.nz

