



OWNER'S MANUAL

ODYSSEY CONTROL

INCLUDING

ODYSSEY LINK



ODYSSEY

TEAMBMPRO.COM

SAFETY PRECAUTIONS

Please read the Safety Precautions before installing or using the OdysseyControl and OdysseyLink. Be sure to observe all precautions without fail. Failure to observe these instructions properly may result in personal damage, or personal injury which depending on the circumstances may be serious and cause loss of life.

WARNING

WARNING: Do not ingest battery. Chemical Burn Hazard



This product contains a coin/button cell battery. If the coin/button battery is swallowed, it can cause severe internal burns in just 2 hours and can lead to death. Keep new and used batteries away from children. If the battery compartment does not close securely, stop using the product and keep it away from children. If you think batteries might have been swallowed or placed inside any part of the body, seek immediate medical attention.



Do not drop or vigorously shake the product as this may cause damage. Do not shock the product, its accessories or batteries as this may cause the product or battery to fail, catch fire or explode.



Stay away from magnetic equipment. Radiation may erase the information stored on this product causing it to become inoperative.



Please note that your battery can only reach top performance level only after it has been fully charged and discharged two or three times.



Keep this product and your battery dry and do not expose it to water or water vapour. Do not use this product in areas where it can fall into water, such as, for example, near a pool, pond or bath. Do not operate this product or your battery with wet hands. Contact with water will cause the product or your battery to short-circuit or corrode and may result in electric shock.



Do not use this product in environments that are excessively hot, cold, dusty or humid or where it will be exposed to magnetic fields or long periods of sunshine. Such exposure may cause the product or your battery to fail, catch fire or explode.



Product specifications are subject to change and improve without notice.



Copyright © 2024

REV 9.0

Designed by BM PRO, one of Australia's leading power solution experts, the BM PRO product range is proudly designed and manufactured in Melbourne, Australia, and represent a high-quality product that will provide years of service.

DISCLAIMER: BM PRO accepts no liability for any loss or damage which may occur from the improper or unsafe use of its products. Warranty is only valid if the unit has not been modified or misused by the customer.

CONTENTS

SAFETY PRECAUTIONS	.2
ABOUT THE ODYSSEYCONTROL	.6
SMARTCONNECT	6
ODYSSEY SYSTEM DIAGRAM	7
DESCRIPTION OF PARTS	.8
ODYSSEYCONTROL APP	8
ODYSSEYLINK	12
USING THE ODYSSEY	13
PAIRING THE ODYSSEYLINK	13
REGISTERING YOUR ODYSSEY	14
CONFIGURING A NEW BATTERY	16
CONTROLLING LOADS WITH THE ODYSSEYCONTROL	17
VIEW CUSTOMISATION	18
UPDATING THE ODYSSEY APP ON THE ODYSSEYCONTROL	19
UPDATING THE ODYSSEYLINK FIRMWARE	19
ODYSSEYSWITCHES	20
PAIRING AN ODYSSEYSWITCH TO THE ODYSSEYLINK104	20
UNPAIRING AN ODYSSEYSWITCH FROM THE ODYSSEYLINK104	21
CHECKING THE BATTERY IN YOUR ODYSSEYSWITCH	22
REPLACING THE BATTERY IN YOUR ODYSSEYSWITCH	22

SERVICING 22

FAQS AND TROUBLESHOOTING 23

ODYSSEYCONTROL 23

LOAD CONTROL 25

PAIRING. 28

BATTERY 28

ODYSSEYSWITCHES 28

APPENDICES 30

SPECIFICATIONS 30

COMPLIANCE 31

WARRANTY TERMS AND CONDITIONS 32

ABOUT THE ODYSSEYCONTROL

The OdysseyControl is a sleek, in-built, app-driven battery monitor and control console that operates with BMPRO's BatteryPlus35-II via the OdysseyLink.

Odyssey gives users a new level of comfort and knowledge about the caravan's battery and power consumption including:

- ▣ Full visibility and control of the caravan's battery system including battery status, power consumption and available charge sources
- ▣ Monitoring of clean and dirty water tanks and caravan temperature
- ▣ Control of caravan features, including lights, slide-out and water pumps from the OdysseyControl or OdysseySwitches

OdysseySwitches are only compatible with the OdysseyLink104. They will not work with older versions of the OdysseyLink.

SMARTCONNECT

Odyssey is SmartConnect ready!

With SmartConnect, you can remotely control various aspects of your caravan, such as tyre pressure, gas bottle levels and caravan temperatures through the OdysseyControl or Odyssey App by using a range of Bluetooth sensors connected to Odyssey.

SmartConnect sensors are compatible only with OdysseyLink103 and OdysseyLink104.

For more details, refer to teambmpro.com/products/smartconnect

ODYSSEY SYSTEM DIAGRAM

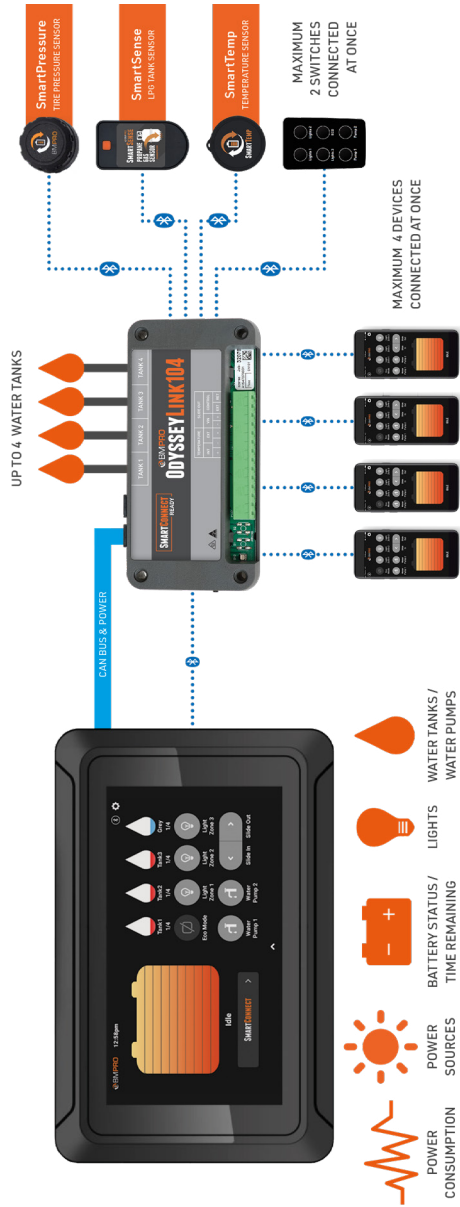

DESCRIPTION OF PARTS

ODYSSEYCONTROL APP



1. Pairing Status

Indicates the Bluetooth pairing status between the OdysseyControl and the OdysseyLink.

ICON	PAIRING STATUS
	CONNECTED
	DISCONNECTED

WARNING

When Bluetooth is disconnected, any information displayed on the OdysseyControl will be incorrect. When Bluetooth connection is re-established, the OdysseyControl will update to reflect correct battery usage.

2. Settings Menu

Provides access to the OdysseyControl settings and functions.

3. Tanks

Monitor water levels of up to 4 water tanks. Tank properties, such as name and water source (i.e. clean or dirty water) are configurable via the Settings Menu.

When a 'Clean' tank is almost empty, the tank will turn red to indicate the tank is almost out of water.

A 'Dirty' tank will turn red when the tank is full and needs emptying.

4. ECO Mode

ECO Mode powers off all caravan loads connected to the BatteryPlus35-II load terminal block except for terminal 1. Battery charging is not affected by ECO Mode. Monitoring of battery usage is still available from the OdysseyControl.

As the caravan loads are no longer powered, ECO Mode is a convenient way to save remaining power of your battery if you are on the road and have limited ability to charge the battery.

When charging, ECO Mode ensures that all available charging current is dedicated to charging your battery.

ECO Mode functionality does not require any specific output wiring combination, as it is backend software configured internally to the BatteryPlus35-II.

5. Light Zones

Used to turn lights in three dedicated zones on and off. Lights may be renamed via the Settings Menu.

6. Water Pumps

Used to turn water pumps on and off.

7. Slide-outs

Used to engage the caravan's slide-out mechanism. Release the button to stop the movement.

As a safety precaution, if the BatteryPlus35-II is connected and receiving power from the AUX source, you will not be able to operate slide-outs from the OdysseyControl. This safety feature prevents the caravan's slide-out mechanism from operating while you are driving on the road. Operation of slide-outs from the OdysseyControl will become available when the towing vehicle is parked.

8. Battery Status

Displays the battery's power capacity and usage.

BATTERY STATUS	
CHARGING	The BatteryPlus35-II is charging the battery-denoted by the lightening symbol
DISCHARGING	Indicates the caravan's battery is in use and the time remaining before the battery is completely discharged
IDLE	Indicates that no current is flowing into or out of the caravan battery

9. SmartConnect

Used to access the SmartConnect sensor screen.

10. Swipe Up

Swipe up to access more information on caravan battery and power consumption.



11. Battery Amps

Indicates the charging/discharging current of the battery connected to the BatteryPlus35-II.

12. Battery Volts

Indicates the voltage of the battery connected to the BatteryPlus35-II.

13. Input Source

Indicates the power sources used for charging your battery and powering the caravan loads.

14. Loads

Indicates the current supplied by the BatteryPlus35-II to power all loads connected to the BatteryPlus35-II.

15. Temperature

Indicates the temperature of the caravan.

The wired temperature sensor must be connected to the "INT + / -" terminal of the OdysseyLink.

ODYSSEYLINK



1. Pairing Button

Used to enable Bluetooth pairing between the OdysseyLink and the OdysseyControl.

2. LED Status Indicator

Indicates the operational/pairing status of the OdysseyLink. The LED will blink green if the OdysseyLink is ready to pair to the OdysseyControl.

3. Serial Number

Required when pairing the OdysseyLink to the OdysseyControl.

USING THE ODYSSEY

PAIRING THE ODYSSEYLINK

To pair the OdysseyLink to the OdysseyControl:

1. Make sure that the OdysseyLink is connected to the BatteryPlus35-II and the BatteryPlus35-II is powered on.
2. Press the Pairing Button on the OdysseyLink. The LED Status Indicator on the OdysseyLink will flash green, indicating you have 30 seconds to pair the OdysseyLink to the OdysseyControl.
3. Launch the Odyssey App and press scan at the prompt. If the Odyssey App requests access to the device's location, allow access.
4. The Odyssey App will now search for nearby OdysseyLink devices. Once this is complete a pop-up window will appear with a list of OdysseyLink devices available for connection.
5. Select the device with the number that corresponds to the last six digits of the serial number of the OdysseyLink you wish to pair to.

If successful, the Pairing Status icon on the Odyssey App will show that the OdysseyControl and OdysseyLink are connected.

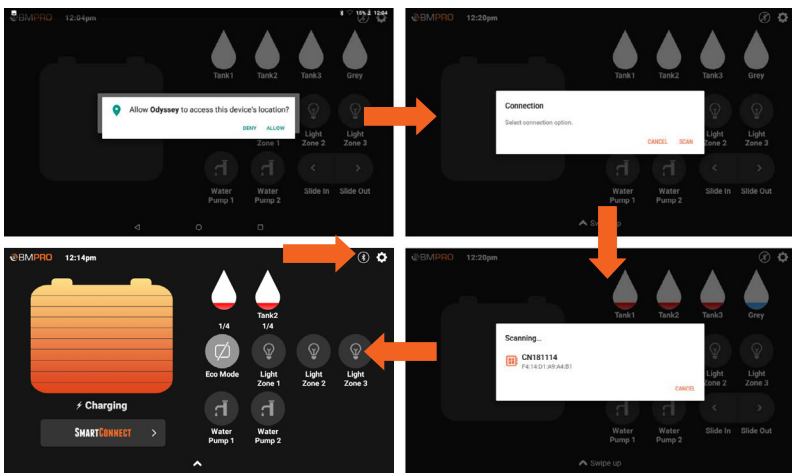

REGISTERING YOUR ODYSSEY

If you have not registered your Odyssey, when you launch the Odyssey App you will be greeted with the registration screen.

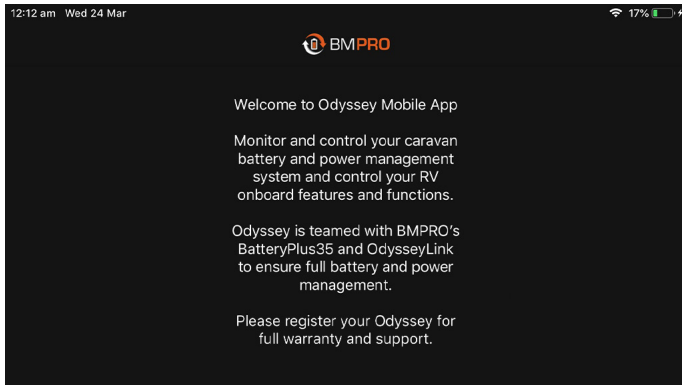

To register your Odyssey:

1. Scroll down and press **Register**.

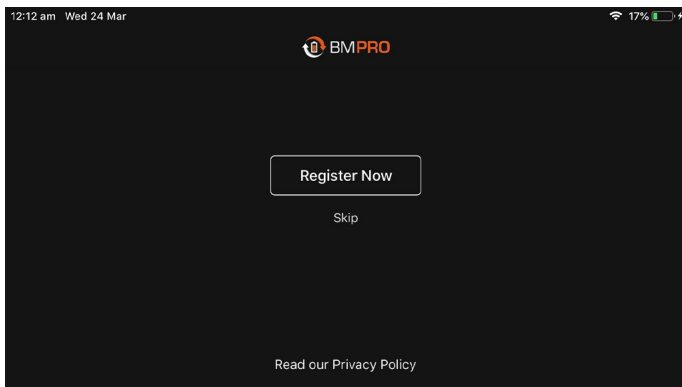

2. Enter your name and email address.
3. Select your RV brand.
4. Choose whether your RV is new or used.
5. Press **Save**.

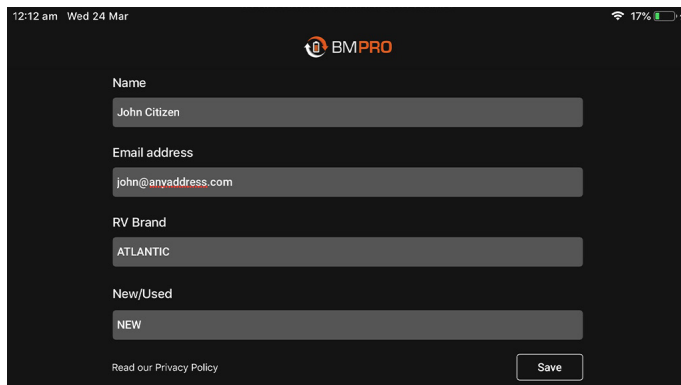

The image shows a mobile application interface for BM PRO. At the top, the status bar displays "12:12 am Wed 24 Mar" and "17%". The BM PRO logo is centered at the top. Below the logo, there are four input fields with labels: "Name" (containing "John Citizen"), "Email address" (containing "john@anvaddress.com"), "RV Brand" (containing "ATLANTIC"), and "New/Used" (containing "NEW"). At the bottom left, there is a link "Read our Privacy Policy". At the bottom right, there is a "Save" button.

Your Odyssey is now registered with BM PRO.

CONFIGURING A NEW BATTERY

Whenever you replace your caravan battery, make sure that it is configured with the OdysseyControl.

Correctly configuring the battery capacity will ensure that the BatteryPlus35-II will select the best charging parameters for the caravan battery in use and the software accurately estimates battery usage, including battery capacity and time remaining.

To configure a new battery:

1. Power down the BatteryPlus35-II.
2. Replace the battery.
3. From the OdysseyControl, repower the BatteryPlus35-II.
4. Press the Settings button. 
5. Scroll down to the **Battery Capacity** field.
6. In the **Battery Capacity** field, enter your battery's battery capacity in Ampere-hours (the default is 100 Ah).
7. In the Battery Profile section, select the battery profile that matches your battery (the default is Lead-Acid).

You cannot select a battery profile if your BatteryPlus35-II is incompatible with lithium charging.

8. Press  to return to the Odyssey App home screen.

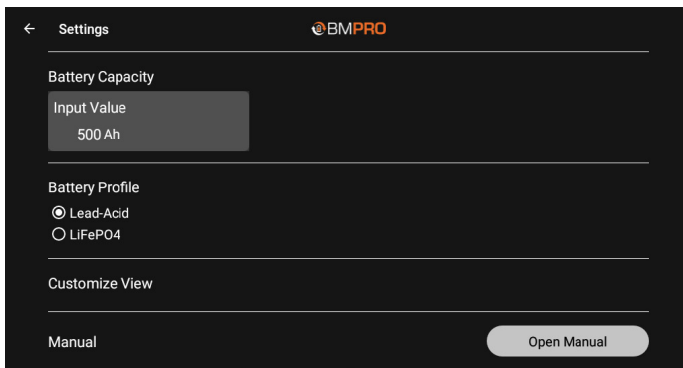

CONTROLLING LOADS WITH THE ODYSSEYCONTROL

Controlling loads is as simple as pushing a button. A light grey icon indicates the load is on, and a dark grey icon indicates the load is off.

The following examples describe situations in which a load is unable to be used.

Low Battery Voltage

If the caravan's battery voltage drops to low levels, the BatteryPlus35-II will automatically enter ECO Mode, stopping power to all caravan loads connected to the BatteryPlus35-II load terminal block (except terminal 1). In ECO mode, load control from the OdysseyControl is disabled. You will still be able to monitor the battery capacity and consumption with the OdysseyControl.

If the caravan's battery voltage continues to drop, the BatteryPlus35-II will then enter Storage Mode, and the OdysseyLink will no longer receive power through the communication bus. The OdysseyLink will disconnect Bluetooth communication to the OdysseyControl. Monitoring of battery capacity and consumption will no longer be available.

This is to conserve remaining available battery power until the battery can be charged.

User-Enabled ECO Mode

Control of caravan loads from the OdysseyControl will be unavailable if you enable ECO Mode from the Odyssey App. To regain control of the caravan loads, turn ECO Mode off.

User-Enabled Storage Mode

Control of caravan loads from the OdysseyControl will be unavailable if you activate the Remote Switch connected to the BatteryPlus35-II to enter Storage Mode. To regain control of the caravan loads, switch the Remote Switch off.

VIEW CUSTOMISATION

You can customise the appearance of the Odyssey App based on your RV accessories by going into **Customise View** in the Settings menu.

By customising the view, you can disable features not available in your RV, such as slides or water tanks.

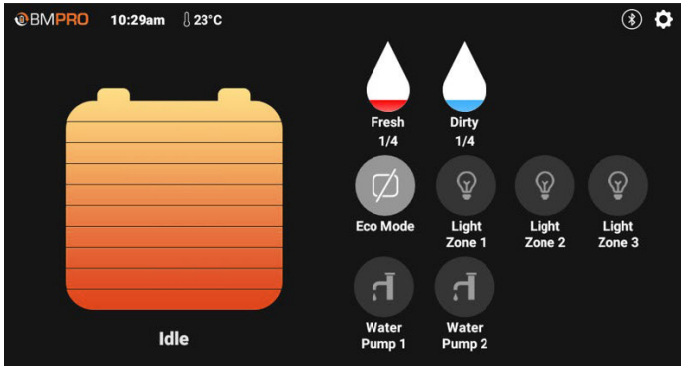

UPDATING THE ODYSSEY APP ON THE ODYSSEYCONTROL

The OdysseyControl is set up to automatically receive Odyssey App updates when they become available, as long as the OdysseyControl is connected to the internet and logged in to a Google account.

UPDATING THE ODYSSEYLINK FIRMWARE

When the OdysseyControl is connected to the OdysseyLink and detects the firmware version on the OdysseyLink is out of date, the Odyssey App will automatically begin performing a firmware update.

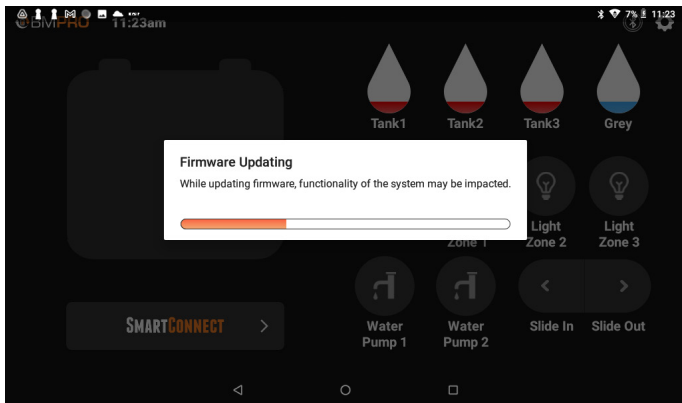

Once the firmware update is complete, a message will appear.

Press **Done** to return to the OdysseyControl.

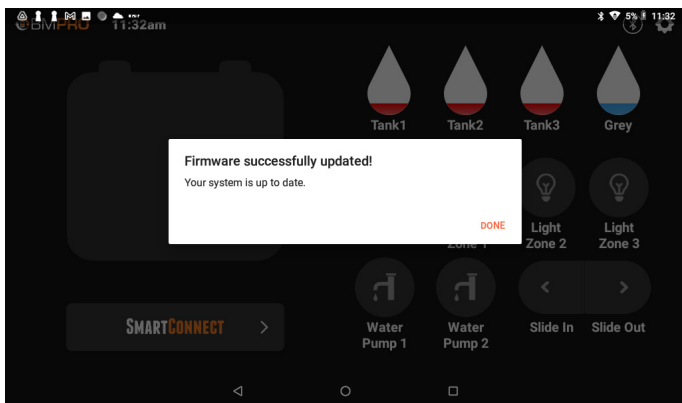

ODYSSEYSWITCHES

OdysseySwitches (also known as SmartSwitches) communicate via Bluetooth to the OdysseyLink104, giving you additional control of RV features.

OdysseySwitches are only compatible with the OdysseyLink104. They will not work with older versions of the OdysseyLink.

Any OdysseySwitch you install has been paired to the OdysseyLink at the factory and is ready for immediate use. If an OdysseySwitch isn't responding, it may need to be re-paired.

PAIRING AN ODYSSEYSWITCH TO THE ODYSSEYLINK104

Up to two OdysseySwitches can be paired to the OdysseyLink104.

To pair a OdysseySwitch to the OdysseyLink104:

1. From the App home screen, press the Settings button. 
2. Press **Wall Switches**.
3. Press **Add**.

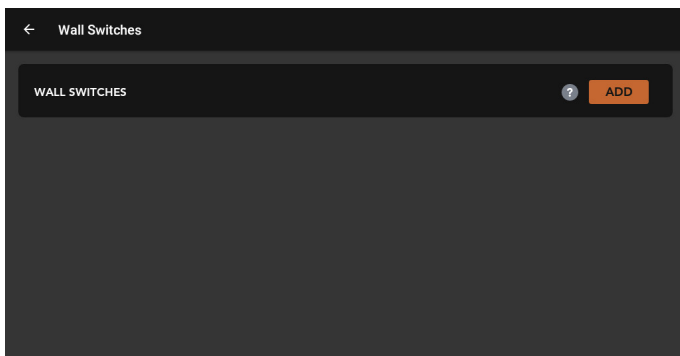

4. On the OdysseySwitch you want to pair, press any two buttons at the same time.
5. Once pairing is successful, the newly-paired OdysseySwitch will appear in the Wall Switches list.



UNPAIRING AN ODYSSEYSWITCH FROM THE ODYSSEYLINK104

To unpair an OdysseySwitch from the OdysseyLink104:

1. From the App home screen, press the Settings button. 
2. Press **Wall Switches**.
3. Next to Remove wall switches, press **Unpair**.
4. Red Unpair buttons will appear next to the OdysseySwitch listings. Next to the OdysseySwitch you want to unpair, press **Unpair**.
5. Press **Done**.

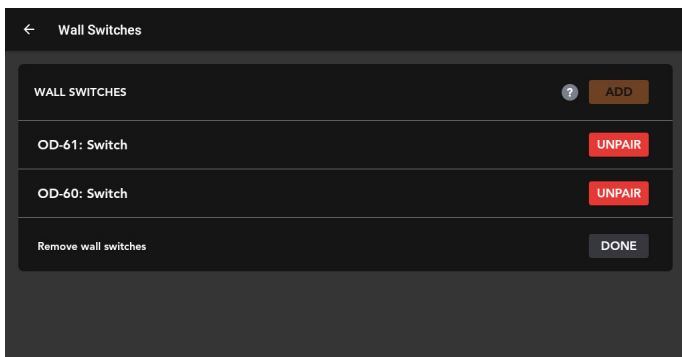

CHECKING THE BATTERY IN YOUR ODYSSEYSWITCH

OdysseySwitch are powered by a standard CR2032 3V Lithium Cell coin battery. To check if the battery needs replacing:

1. From the App home screen, press the Settings button. 
2. Press **Battery Levels**.
3. Press any button on the OdysseySwitch you are checking.

Once the button has been pressed, the App will refresh with the OdysseySwitch battery status.

REPLACING THE BATTERY IN YOUR ODYSSEYSWITCH

To replace the battery in an OdysseySwitch:

1. Unclip the OdysseySwitch button pad.
2. Using a flathead screwdriver, pry open the OdysseySwitch button pad and remove the battery from the holder.
3. Insert the new battery in the holder with the positive side facing up.

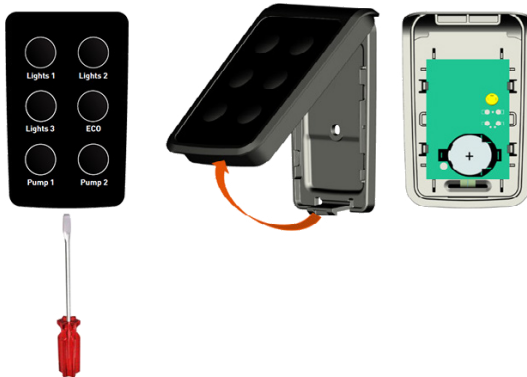

SERVICING

Do not attempt to service the OdysseyControl or OdysseyLink yourself, OR dismantle, modify or repair the OdysseyControl or OdysseyLink yourself; this will void your warranty. If your OdysseyControl or OdysseyLink requires servicing, please consult your BMPRO dealer or visit teambmpro.com for assistance.



FAQS AND TROUBLESHOOTING

Need more help troubleshooting your OdysseyControl or OdysseyLink? Contact our customer service team on line at teambmpro.com/technical-support or check out our how-to videos on our YouTube channel at youtube.com/c/bmproau

ODYSSEYCONTROL

Does the OdysseyControl connect to Wi-Fi?

Yes, the OdysseyControl can connect to your local Wi-Fi network:

1. At the bottom of the screen, press the main screen icon  to return to the OdysseyControl main screen.
2. From the main screen, press the Settings icon. 
3. Select Network & Internet and then Wi-Fi, then choose and connect to your Wi-Fi network.

How do I update the Odyssey App on my OdysseyControl?

The OdysseyControl is set up to automatically receive Odyssey App updates. Just make sure that you are:

1. Connected to the internet.
2. Logged into your Google account.

The Odyssey App will automatically update whenever a new release is available.

How do I create a Google account?

If you don't have a Google account, you can create one by pressing the Google Play icon on the OdysseyControl main screen and following the prompts.

If you need more help creating a Google account, **check out our online guide.**

The screen on my OdysseyControl is frozen. What do I do?

If the screen on your OdysseyControl is frozen, reset it by inserting a small thin object, such as a paper clip, into the reset pin hole.

If your OdysseyControl is an OD-C101, the reset pin hole is located on the top, as shown below.

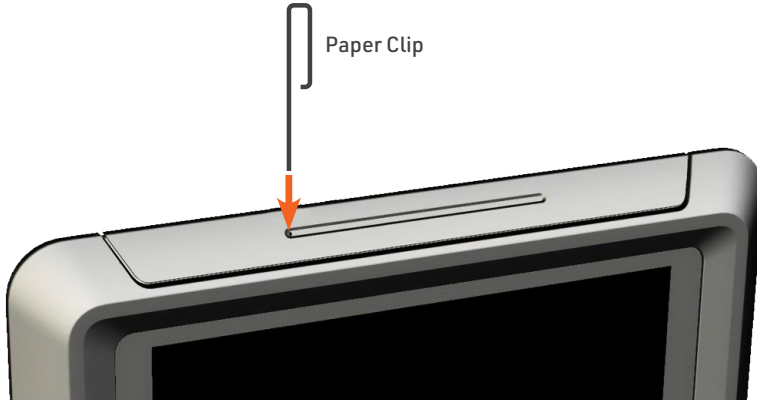

If your OdysseyControl is an OD-C201, the reset pin hole is located on the bottom, as shown below.

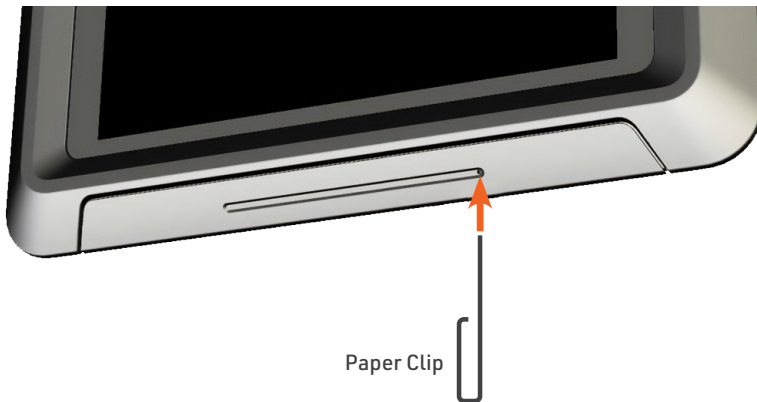

If you do not know if you have an OD-C101 or OD-C201, check the top right corner of the screen for a battery charge indicator.



If you have a battery charge indicator, you have an OD-C101. If you do not, you have an OD-C201.

LOAD CONTROL

I think one of my loads is not receiving power?

The load may be faulty. The electronic load fuse that protects the load may have been activated, which will turn the faulty load off. If this is the case, the LED Status Indicator on the BatteryPlus35-II will flash a solid red.

Please disconnect the faulty load from the BatteryPlus35-II.

None of my loads appear to be powered and I can't use the OdysseyControl to power the loads on again?

In this situation, when you attempt to power loads from the OdysseyControl, the pop-up message that appears will help to diagnose why the loads are no longer powered.

1. ECO Mode is Switched On

This pop-up message will display if the battery button on the OdysseyControl has been selected. The battery icon will be light grey. Press the battery button again to power and regain control of loads.

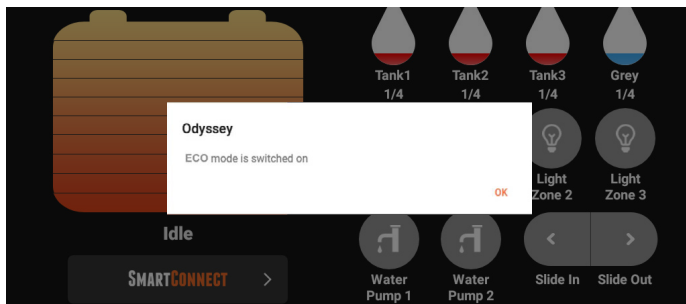

2. Low Voltage Mode is Switched On

This pop-up message will display if the BatteryPlus35-II has entered ECO Mode, which is the first stage of a low voltage disconnection. All icons in the OdysseyControl will be dark grey. The Pairing Status Icon will indicate that the OdysseyControl is paired to the OdysseyLink.

Connect the BatteryPlus35-II to a power source and begin battery charging.

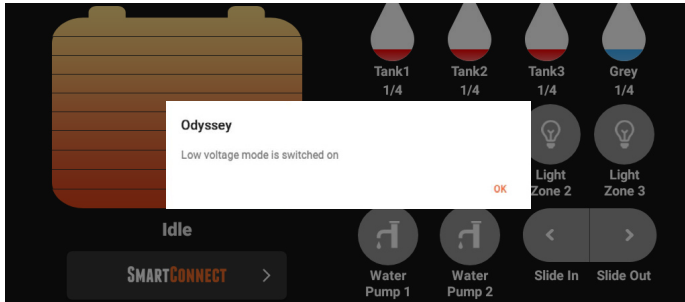

3. There is No Bluetooth Connection

All icons in the Odyssey App will be dark grey.

The Pairing Status Icon will indicate that the OdysseyControl is not paired to the OdysseyLink. This message will display if:

1. The switch connected to the BatteryPlus35-II Remote Switch input is activated. If this is the case, deactivate the switch.
2. The BatteryPlus35-II has entered Storage Mode, which is the second stage of a low voltage disconnection. Connect the BatteryPlus35-II to a power source and begin battery charging.

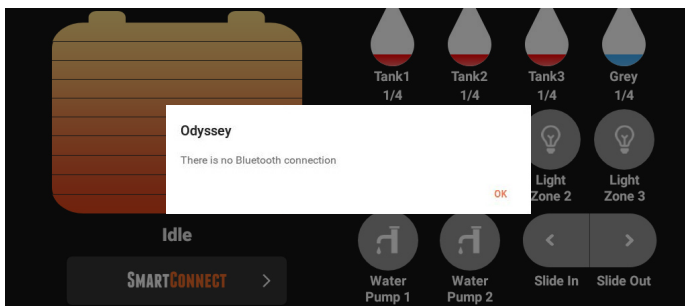

PAIRING

I've paired the OdysseyControl to the OdysseyLink, but the Pairing Status icon shows that they are not connected?

Check the following:

1. Ensure the Bluetooth on the OdysseyControl is turned on.
2. Ensure the switch on the BatteryPlus35-II Remote Switch input is not activated.
3. Ensure the BatteryPlus35-II is not in Storage Mode, as this will turn power to the OdysseyLink off, meaning the OdysseyLink cannot talk to the OdysseyControl.

If the BatteryPlus35-II is in Storage Mode, the operational LED status indicator on the BatteryPlus35-II will emit a single yellow flash. Connect the BatteryPlus35-II to a power source to begin battery charging. When the battery is sufficiently charged, communication between the OdysseyLink and OdysseyControl will be automatically re-established.

BATTERY

I've fitted a battery to the BatteryPlus35-II, but it's not detected in the OdysseyControl?

Check the following:

1. The battery connections are tight and not loose or corroded.
2. The battery polarity, red lead-positive and black lead-negative.
3. The dealership fitted in-line fuse with the caravan battery is fitted and not blown. The correct value is 40A.

ODYSSEYSWITCHES

I've replaced my OdysseySwitch, but the new one doesn't work?

You may need to pair the OdysseySwitch to the OdysseyLink104 before you can use the OdysseySwitch.

For information on pairing OdysseySwitches, refer to the **Pairing an OdysseySwitch to the OdysseyLink104** section.

My OdysseySwitch isn't working even though it is paired?

The OdysseySwitch will only work if the BatteryPlus35-II has been wired as per its designated load outputs.

TERMINAL	DESIGNATED LOAD OUTPUT	LOAD RATING
1	Tablet / Spare	15A
2	Spare	15A
3-9	Spare	10A
10	Light 1	10A
11	Light 2	10A
12	Light 3	10A
13	Pump 1	10A
14	Pump 2	10A

Ensure the BatteryPlus35-II is wired correctly.

APPENDICES

SPECIFICATIONS

ODYSSEYCONTROL	
Input Voltage	5V DC
Input Current	3A
Charger Input Voltage	12V
Communication/Charger Cable	USB to Micro-USB
Dimensions	224mm x 144mm x 17.7mm
Weight	0.5 kg

ODYSSEYLINK	
Input Voltage	8-15V DC
Battery Drain	< 21mA
Ambient Temperature	0-50C
Cable Length	0.5m

ODYSSEYSWITCH	
Input Voltage	2.2-3.0V DC
Battery Type	CR2032

COMPLIANCE

This device complies with part 15 of the FCC Rules. Operation is subject to the following two conditions: (1) This device may not cause harmful interference, and (2) this device must accept any interference received, including interference that may cause undesired operation.

Note: This equipment has been tested and found to comply with the limits for a Class B digital device, pursuant to Part 15 of the FCC Rules. These limits are designed to provide reasonable protection against harmful interference in a residential installation. This equipment generates, uses and can radiate radio frequency energy and, if not installed and used in accordance with the instructions, may cause harmful interference to radio communications. However, there is no guarantee that interference will not occur in a particular installation. If this equipment does cause harmful interference to radio or television reception, which can be determined by turning the equipment off and on, the user is encouraged to try to correct the interference by one or more of the following measures:

- Reorient or relocate the receiving antenna,
- Increase the separation between the equipment and receiver,
- Connect the equipment into an outlet on a circuit different from that to which the receiver is connected,
- Consult the dealer or an experienced radio/TV technician for help.

Warning: Any changes or modifications not expressly approved by BMPRO could void the user's authority to operate this equipment.

This device contains licence-exempt transmitter(s) that comply with Innovation, Science and Economic Development Canada's licence-exempt RSS(s). Operation is subject to the following two conditions:

- (1) This device may not cause interference.
- (2) This device must accept any interference, including interference that may cause undesired operation of the device.

L'émetteur/récepteur exempt de licence contenu dans le présent appareil est conforme aux CNR d'Innovation, Sciences et Développement économique Canada applicables aux appareils radio exempts de licence. L'exploitation est autorisée aux deux conditions suivantes:

1. L'appareil ne doit pas produire de brouillage;
2. L'appareil doit accepter tout brouillage radioélectrique subi, même si le brouillage est susceptible d'en compromettre le fonctionnement.



WARRANTY TERMS AND CONDITIONS

Our goods come with guarantees that cannot be excluded under the Australian Consumer Law. You are entitled to a replacement or refund for a major failure and for compensation for any other reasonably foreseeable loss or damage. You are also entitled to have the goods repaired or replaced if the goods fail to be of acceptable quality and the failure does not amount to a major failure.

This warranty is provided by SETEC BMPRO Pty Ltd (ABN) ("BMPRO") for its products. Warranty benefits are applied along with any rights and remedies required by Australian State and Federal legislation that cannot be excluded. No part of this warranty excludes, restricts or modifies any State or Federal legislation relating to the supply of goods and services which cannot be excluded, restricted or modified.

WARRANTY

BMPRO warrants that the product will be free from any faults in materials and workmanship beginning from the original date of purchase under standard application, installation, use and service conditions, subject to the exclusions and limitations detailed below. The warranty period of the product is two years.

If, before the warranty period has ended, a fault occurs with the product and BMPRO finds the product is defective in materials or workmanship, BMPRO at its discretion will subject to further rights accorded by the Australian Consumer Law to either:

- Repair the defective product
- Replace the defective product
- Provide a refund to the purchaser for the price paid at purchase for the defective product.

WARRANTY CLAIMS

Refer to your manual before using the product. Most BMPRO products are designed to be installed by a suitably qualified installer. The products should be carefully inspected by you or your installer before installation for any visible manufacturing faults. If a product has been installed incorrectly, BMPRO accepts no responsibility on top of our consumer guarantee obligations.

1. If a fault covered by warranty occurs, the purchaser must either contact the dealer where the product was purchased within 7 days, or BMPRO at the contact details listed.
2. All warranty claims must include: (a) proof of purchase of the product; (b) complete details of the alleged fault; (c) any relevant documentation related to the fault (such as photographs or maintenance records); (d) return material authorisation (RMA) number.
3. The product must be made available to BMPRO or its authorised installer for inspection and testing within 14 days of contacting BMPRO or the dealer.
4. The reasonable cost of delivery and installation of any products or components of products that have been repaired or replaced to the place of purchase notified to BMPRO is covered by the warranty provided by BMPRO, along with the reasonable costs of removal and return of any products determined by BMPRO to be defective.
5. If, on return to BMPRO or on investigation by BMPRO, inspection and testing determines there is no fault in the product, the purchaser must pay BMPRO's reasonable costs of testing and investigating the product, as well as transportation and shipping costs.

REGISTER A WARRANTY OR REPAIR WITH BMPRO

To register a warranty or repair with BMPRO:

1. Lodge a support request via teambmp.com/technical-support or email customerservice@teambmp.com
2. If agreed with the BMPRO Product Specialist team, register a warranty claim or repair via teambmp.com/warranty-claim or email customerservice@teambmp.com to obtain a Return Material Authorisation (RMA) number.
3. Package and send the product to:

BMPRO Warranty Department
19 Henderson Road
Knoxfield, VIC 3180

Please mark RMA details on the outside of the packaging.

4. Ensure your package also includes a copy of the proof of purchase, a complete description of the fault and your contact details including phone number and return address.

EXCLUSIONS

This warranty will not be applicable where: (a) the product has been altered, modified or repaired by someone other than BMPRO, an authorised installer or a qualified auto electrician; (b) the product has not been installed properly by either the user or manufacturer; (c) BMPRO cannot establish a fault in the product after inspection and testing; (d) the product has been used for purposes other than that for which it was designed; (e) the fault in the product has occurred due to a failure by the purchaser to ensure proper use and maintenance of the product according to BMPRO's instructions, recommendations and specifications (including maintenance); (f) the product has been subjected to abnormal conditions, such as environmental, temperature, water, fire, humidity, pressure, stress or similar; (g) the fault has been caused by abuse, misuse, neglect or accident; (h) the fault has been caused by a power surge or other kind of fault in the supply of electricity; (i) unauthorised parts or accessories have been used on or in relation to the product; (j) the appearance of the Product has deteriorated; or (k) the fault is a result of common wear & tear.

LIMITATIONS

No express warranties or representations are made by BMPRO other than what is set out in this warranty. The absolute limit of BMPRO's liability under this express warranty is the repair or replacement of the product or part of the product.

CONTACT

BMPRO's contact details for warranty claims are:

SETEC BMPRO Pty Ltd
19 Henderson Road,
Knoxfield, VIC 3180
Phone: (03) 9763 0962
Email: customerservice@teambmp.com

Warranty Claim and Product Repair Form:
<https://teambmp.com/warranty-claim/>

Registering your BMPRO product is an important step to ensure that you receive all the benefits you are entitled to.

Please complete the online registration form at <https://teambmp.com/product-registration/> for your new product today.

POWERING YOUR ADVENTURES.



**TEAM
BMPRO
.COM**

BMPRO

customerservice@teambmp.com

19 Henderson Rd, Knoxfield VIC 3180 Australia | Unit 1, 821 E Windsor Ave, Elkhart IN 46514 USA

teambmp.com